

Front

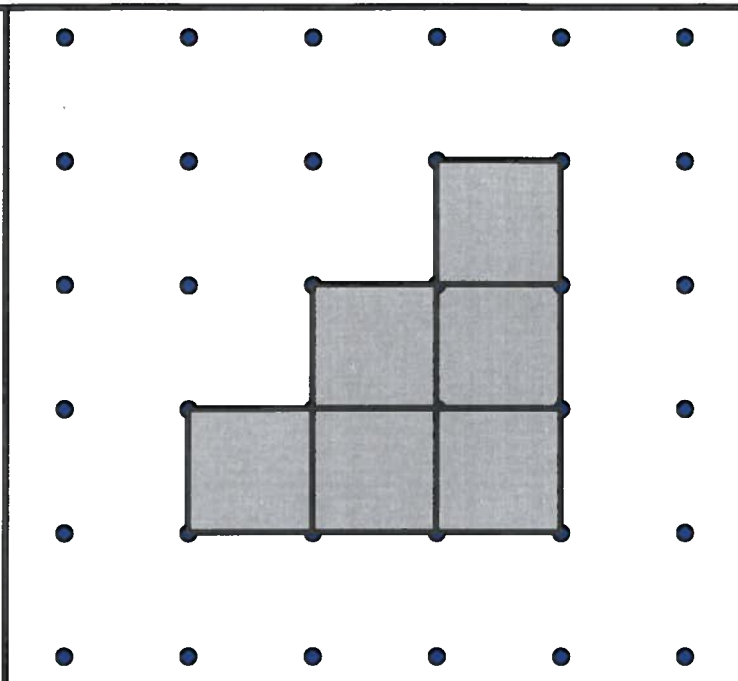

Figure A. Top

Figure A. Front

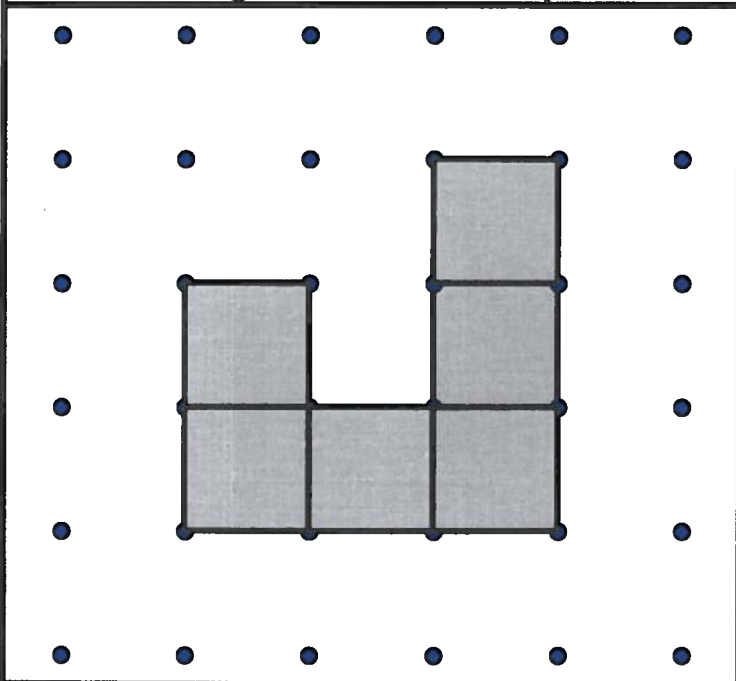

Figure A. Right Side

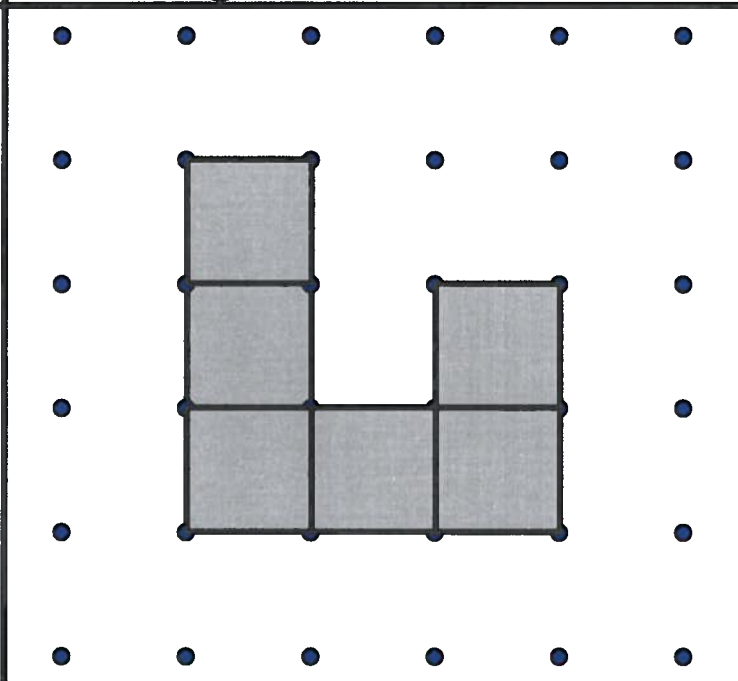

Figure A. Left Side

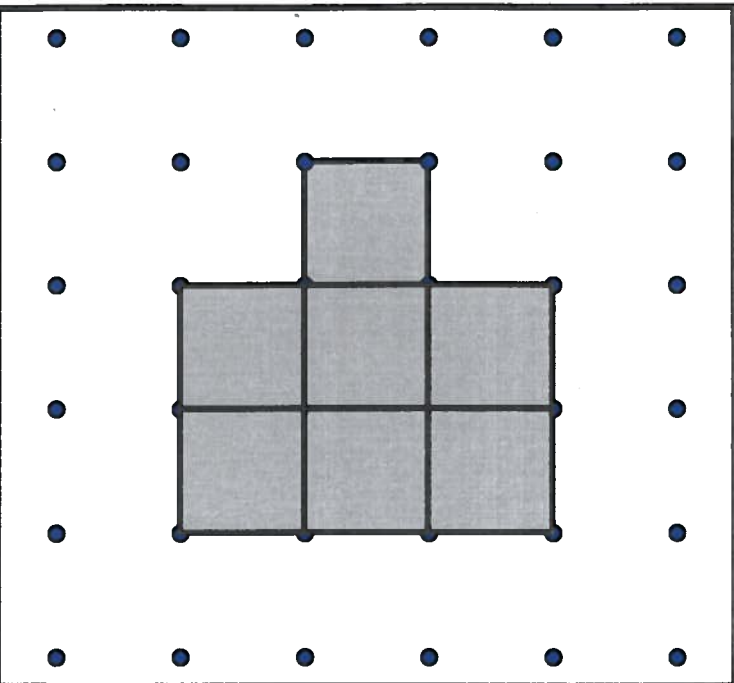
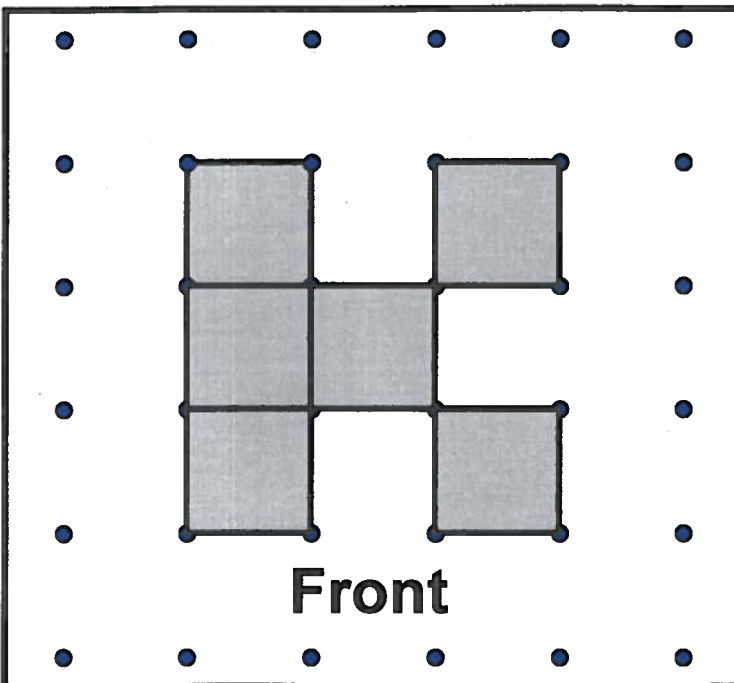

Figure B. Top

Figure B. Front

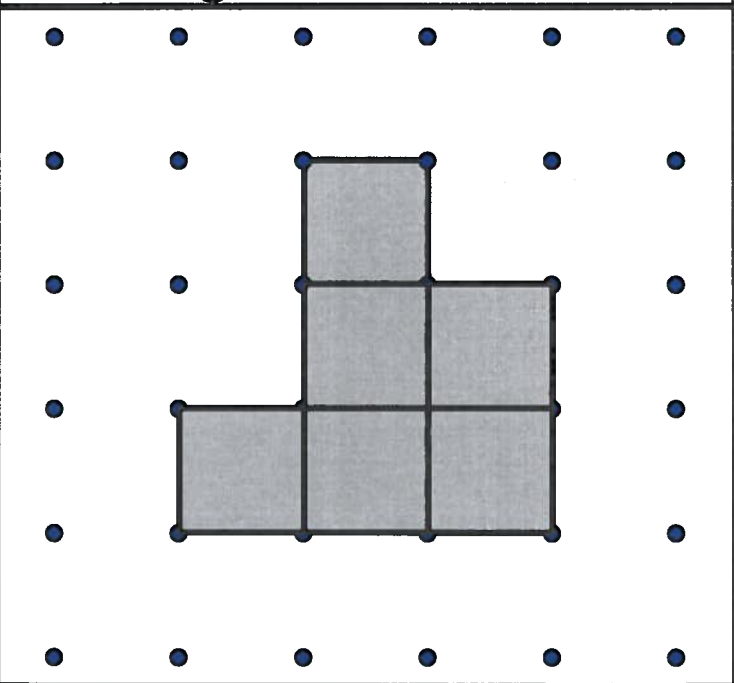
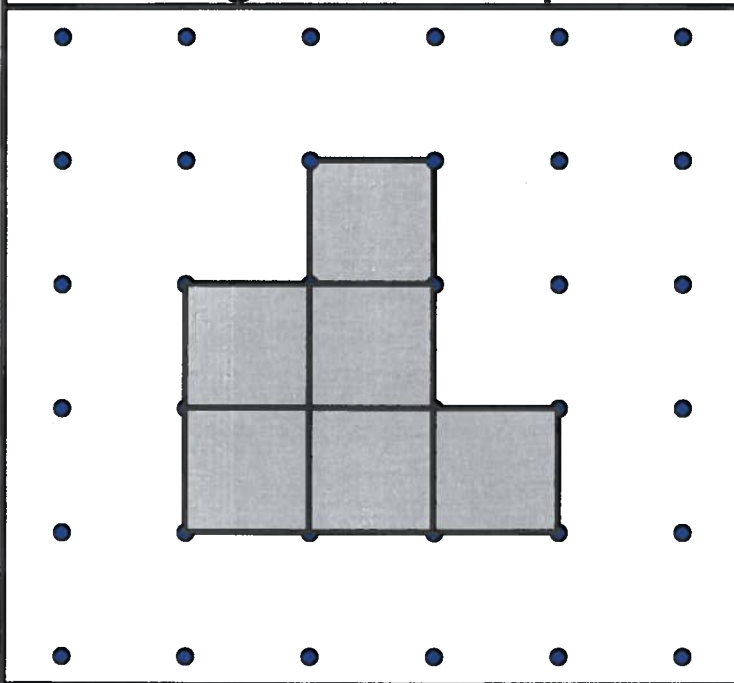
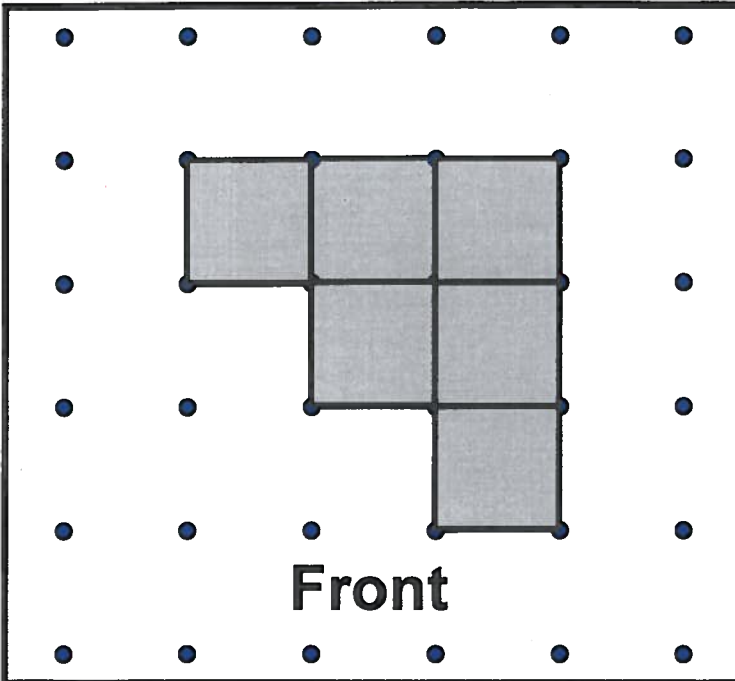

Figure B. Right Side

Figure B. Left Side



Front

Figure C. Top

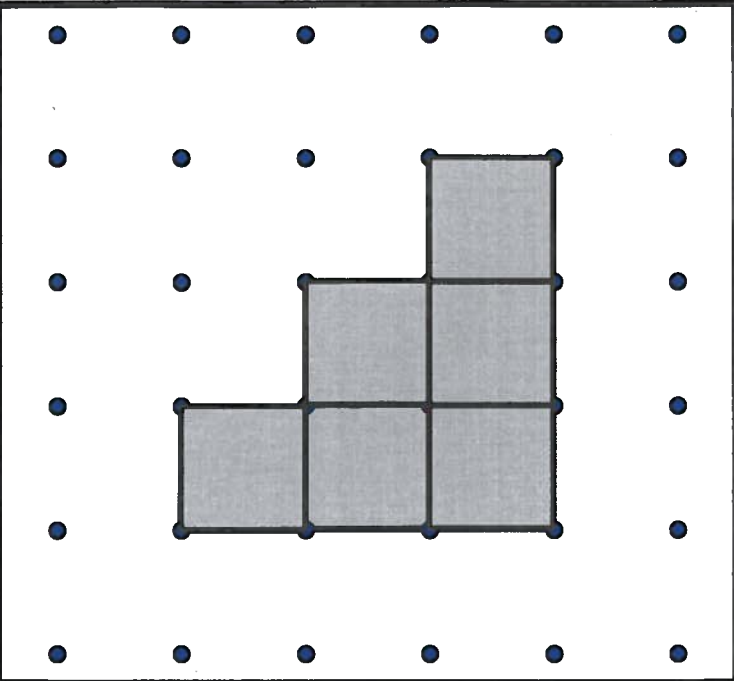

Figure C. Front

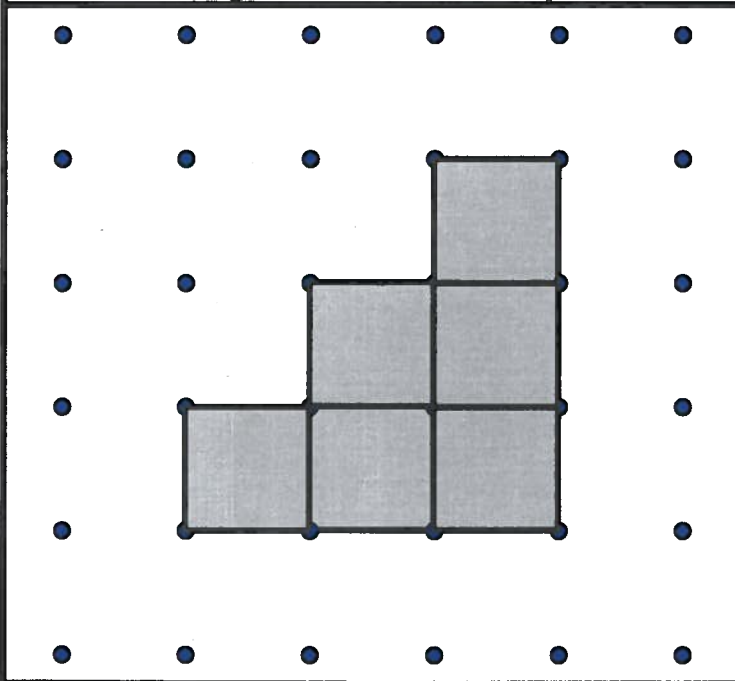

Figure C. Right Side

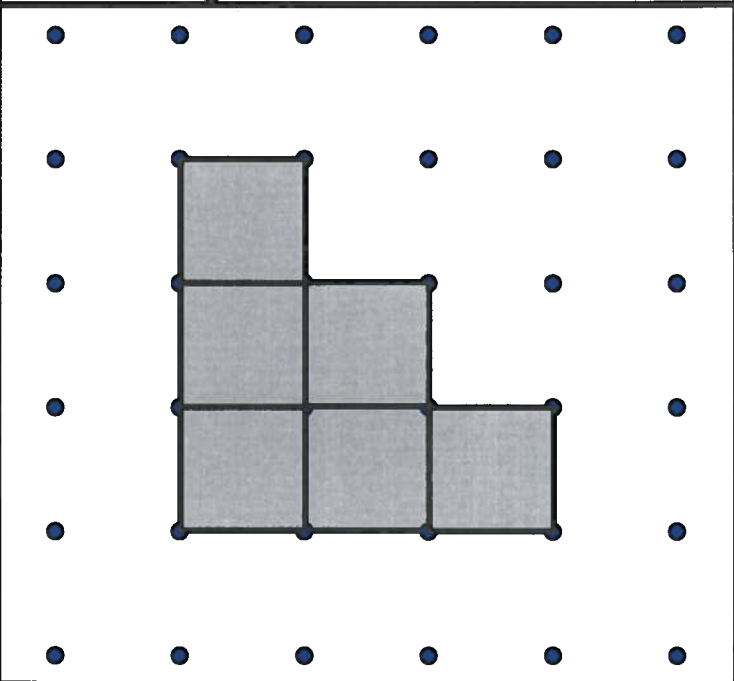

Figure C. Left Side

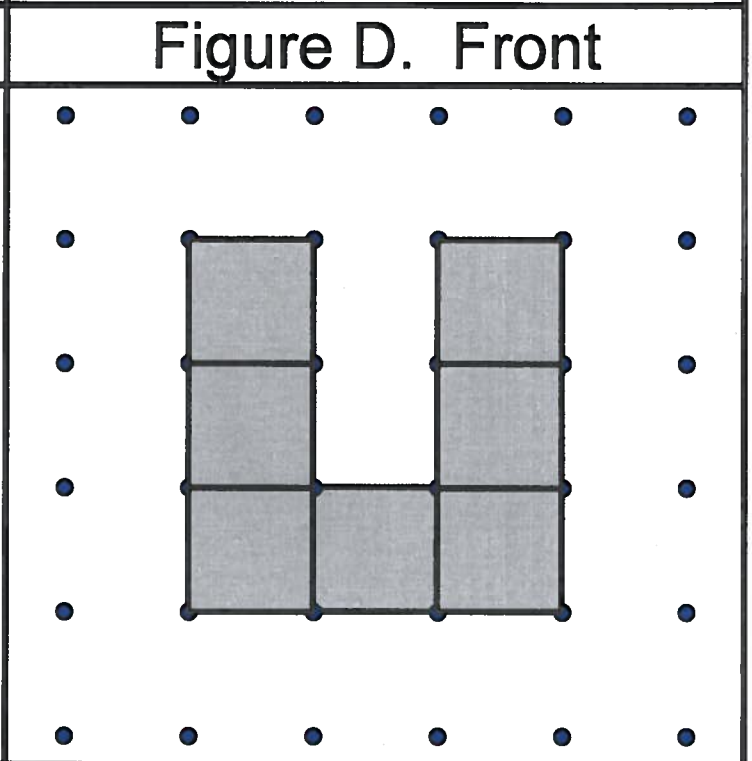
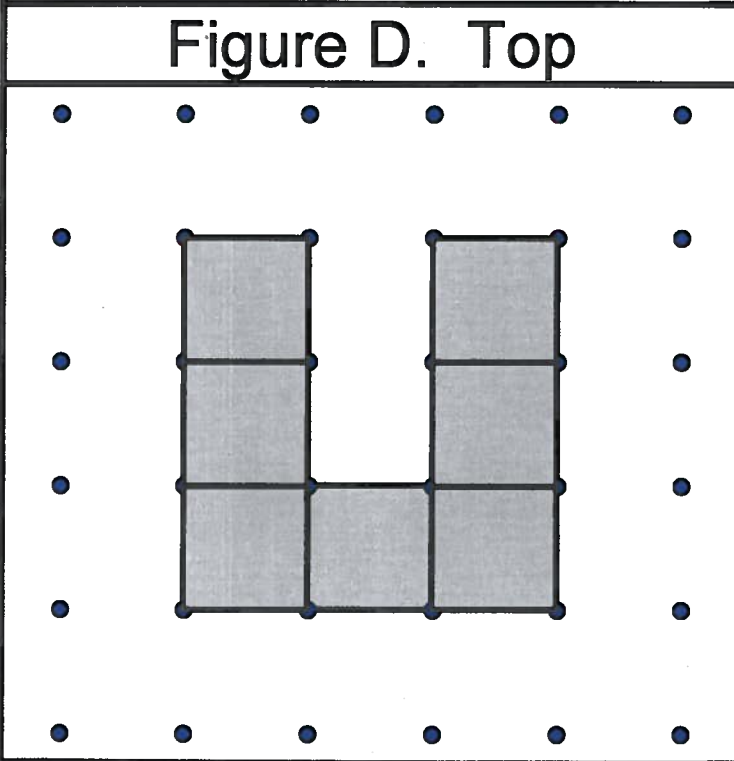
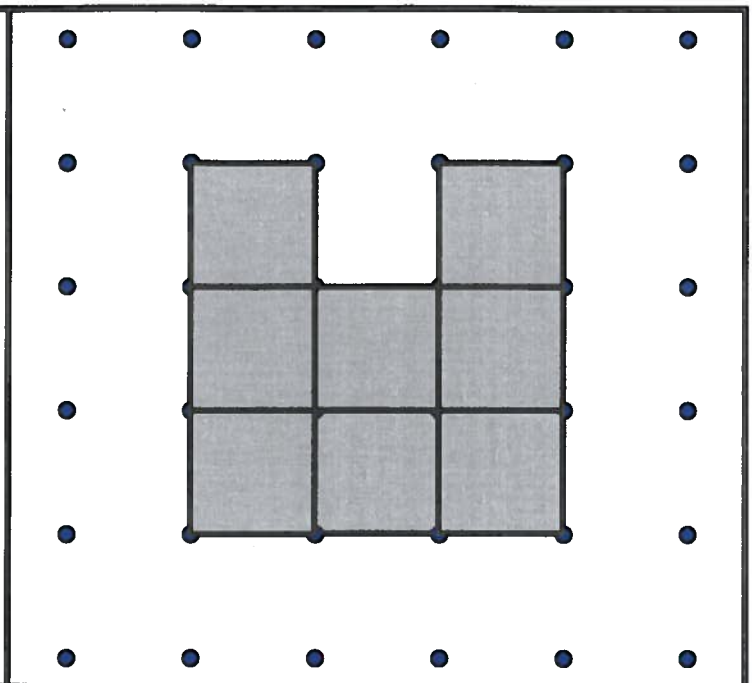
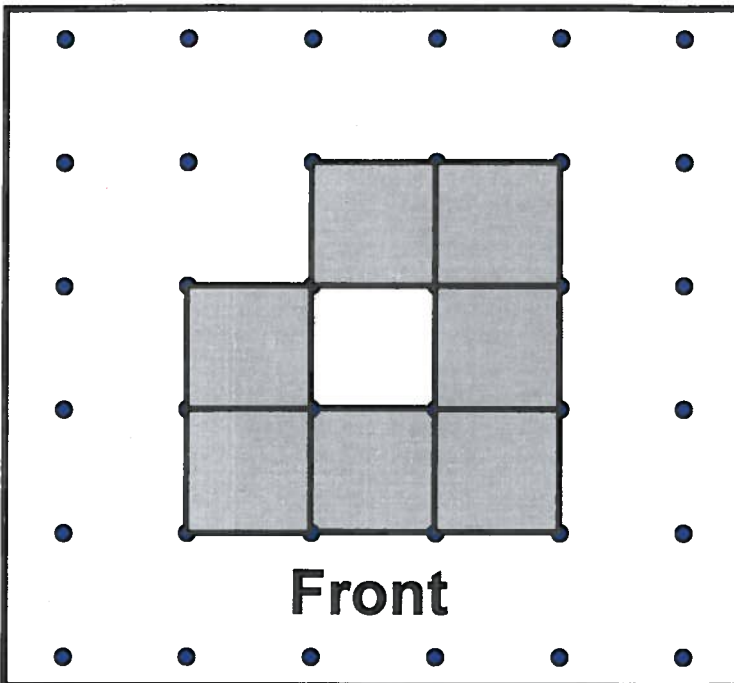

Figure D. Right Side

Figure D. Left Side

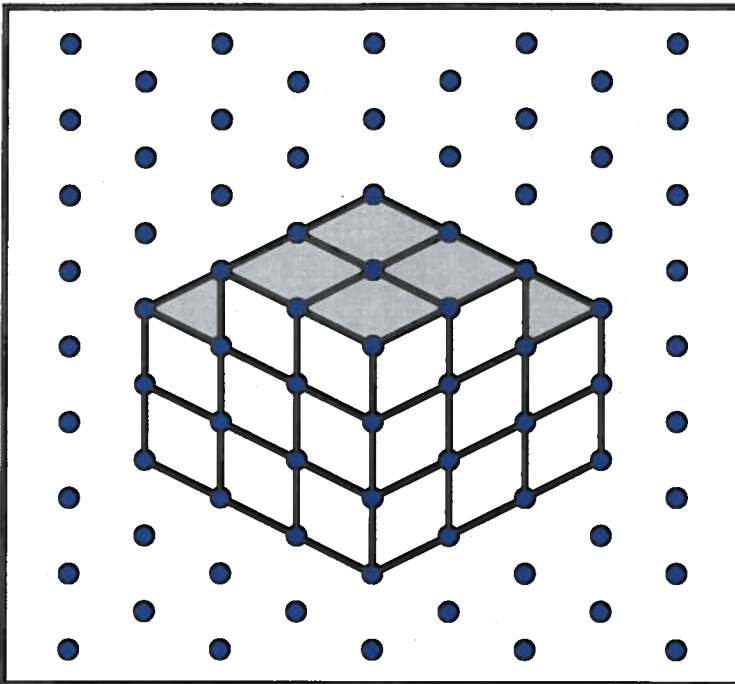

Figure A.1

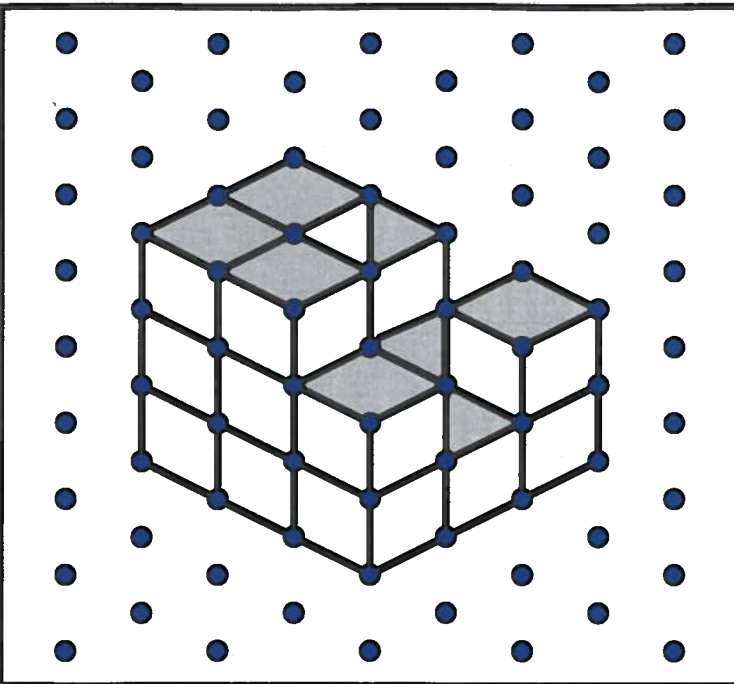

Figure A.2

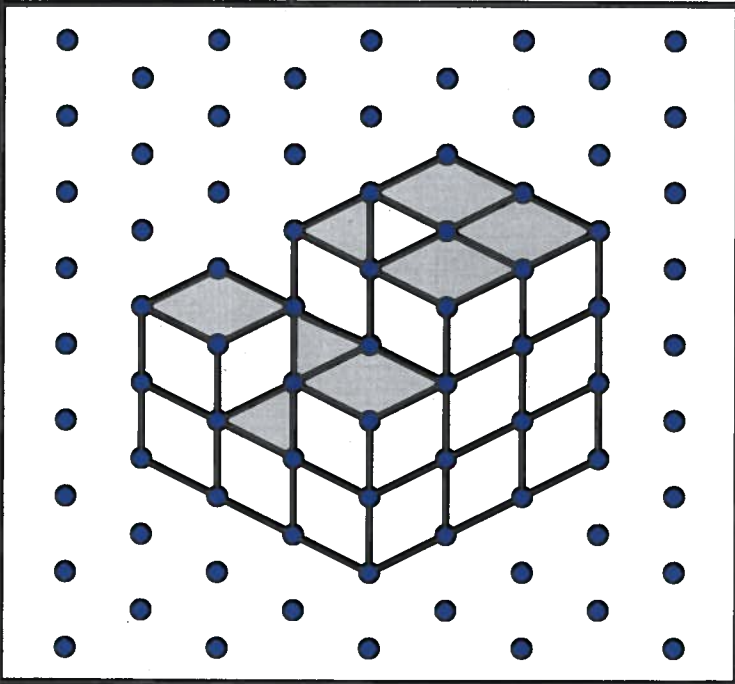

Figure A.3

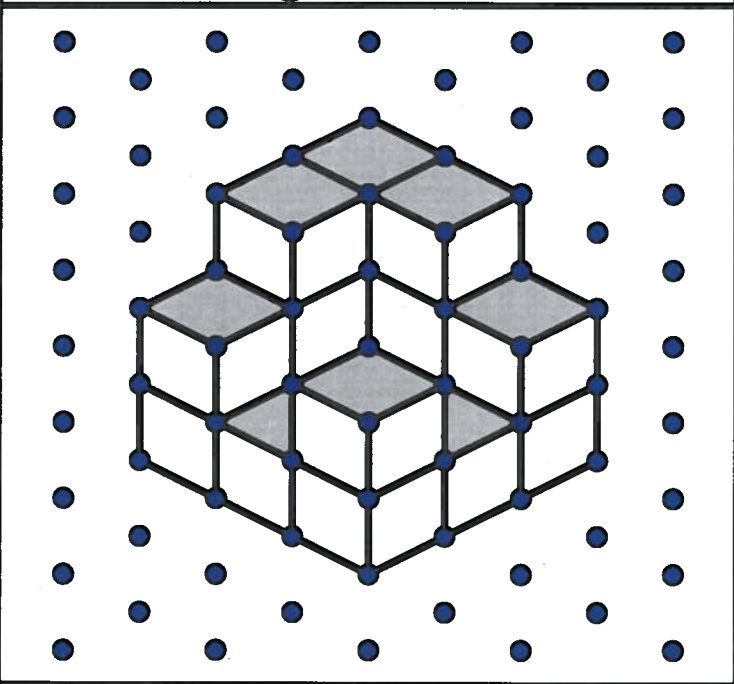

Figure A.4



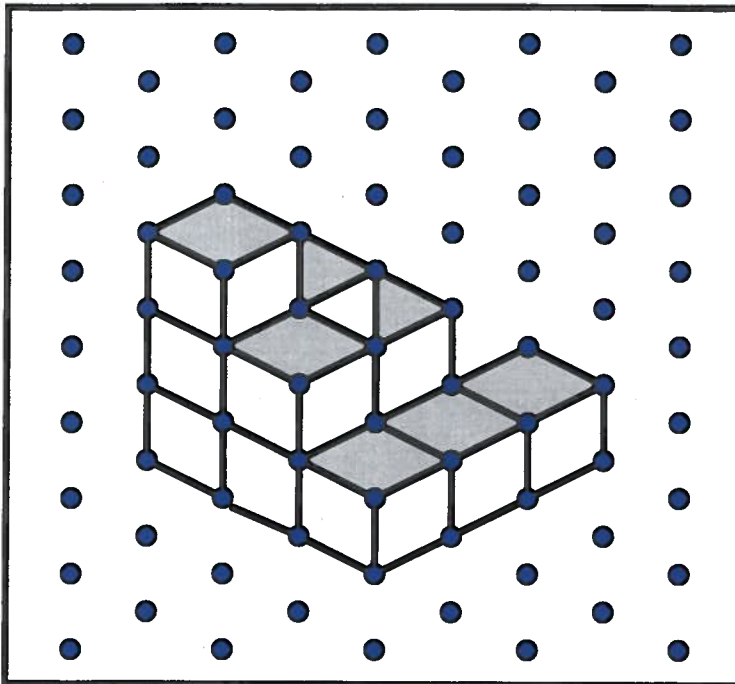

Figure B.1

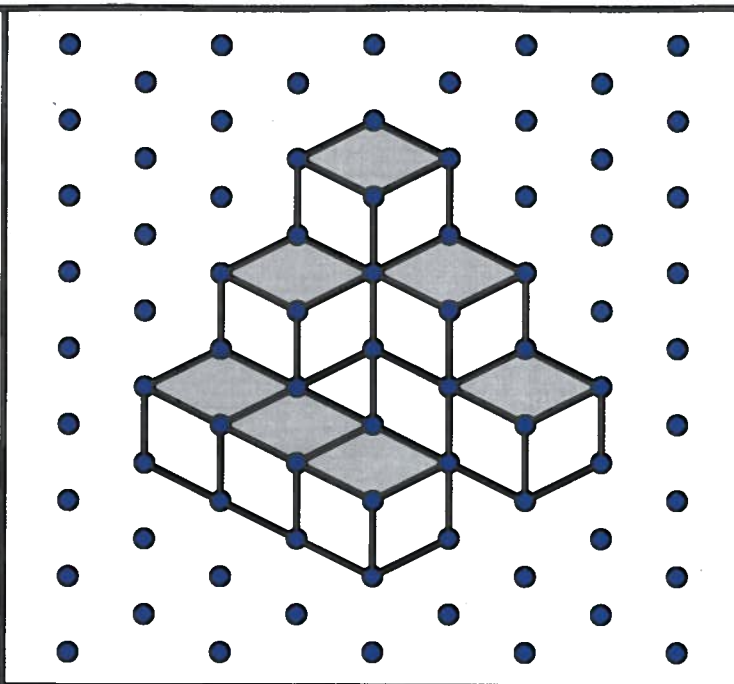

Figure B.2

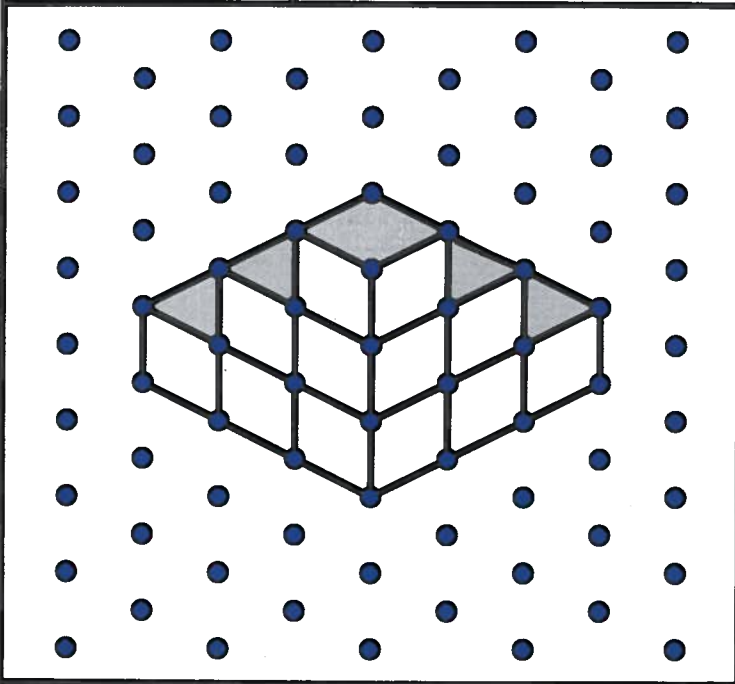

Figure B.3

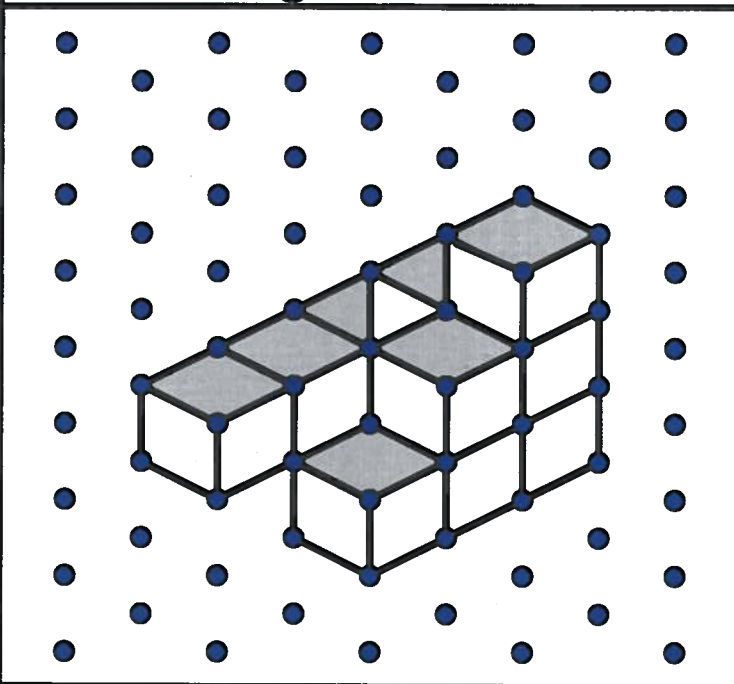

Figure B.4

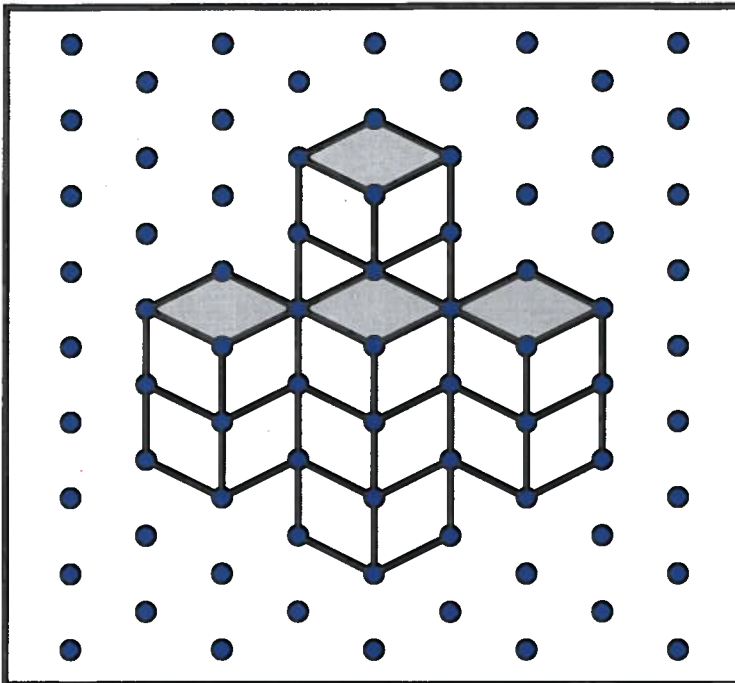

Figure C.1

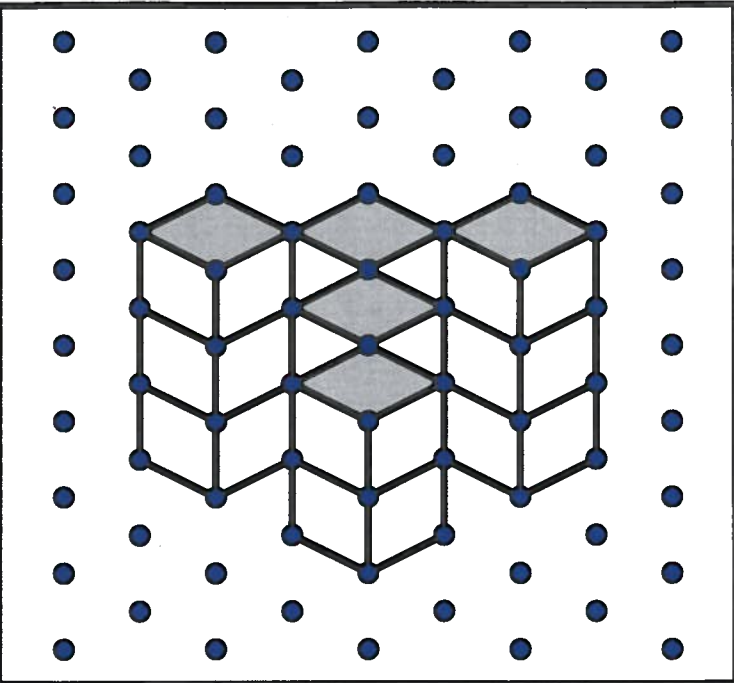

Figure C.2

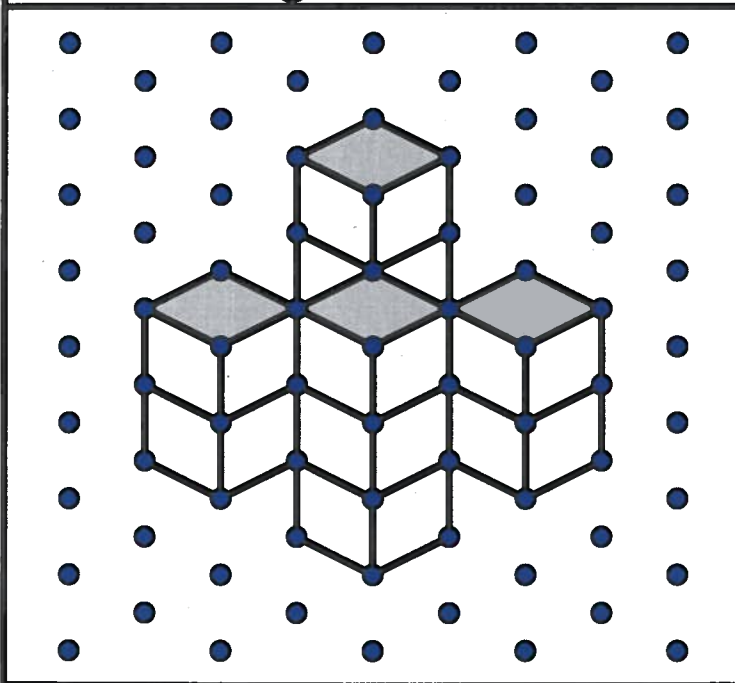

Figure C.3

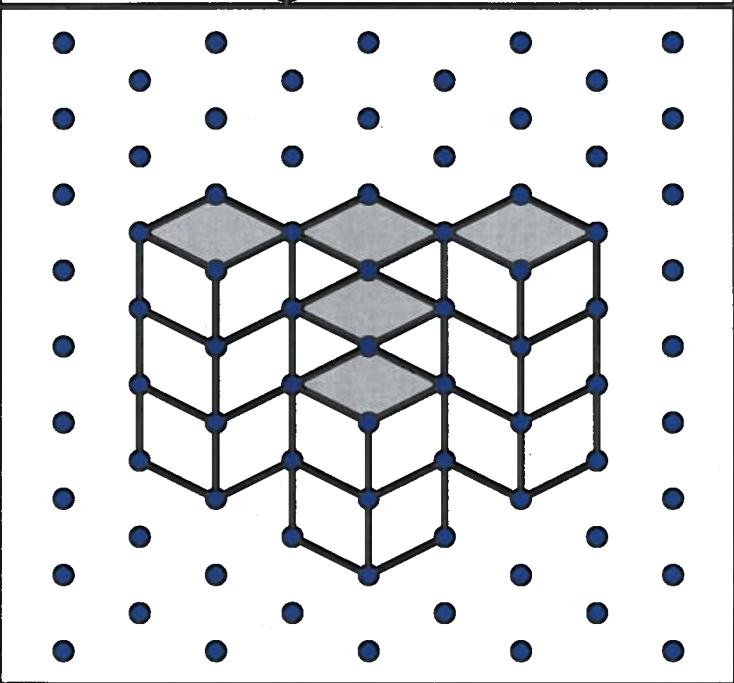

Figure C.4

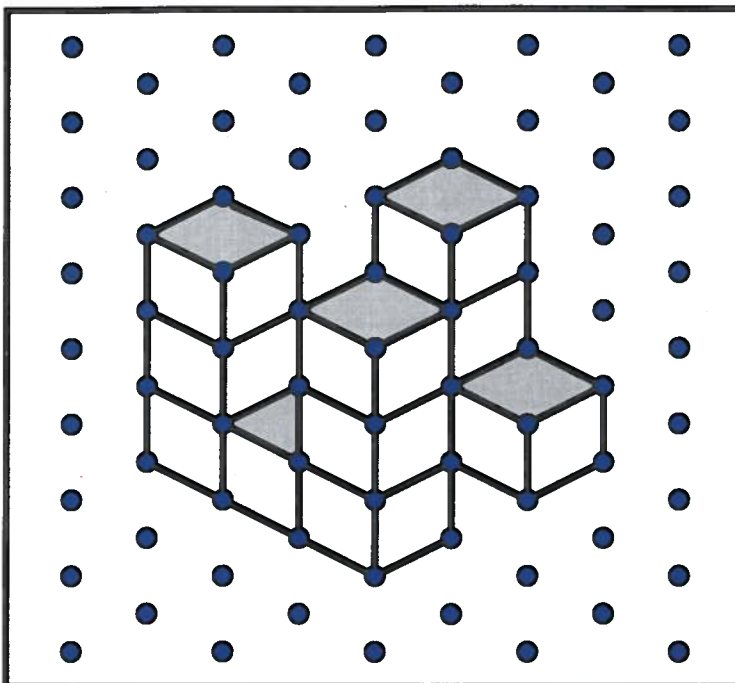

Figure D.1

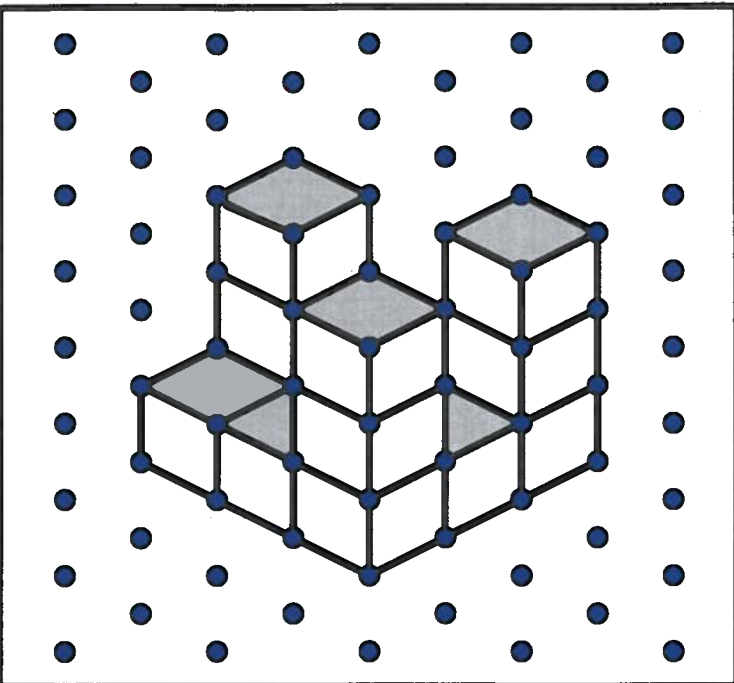

Figure D.2

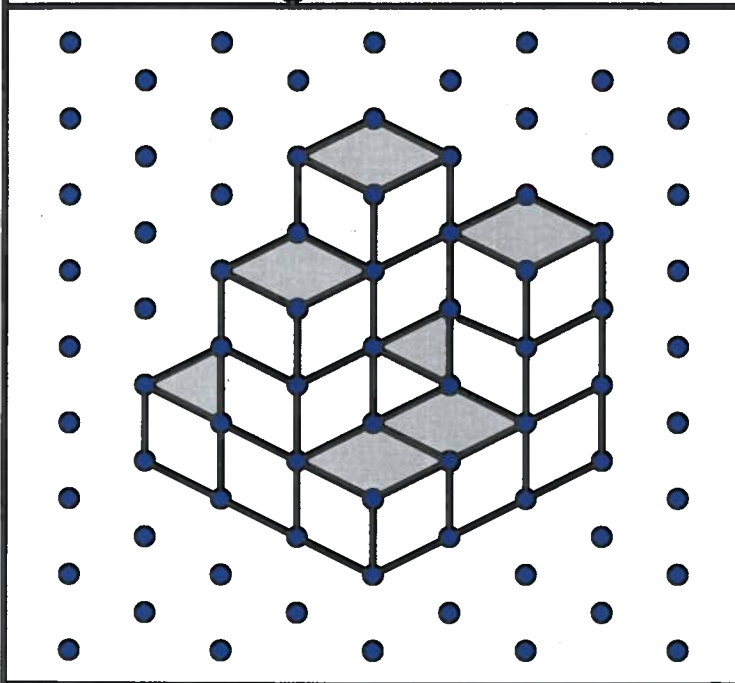

Figure D.3

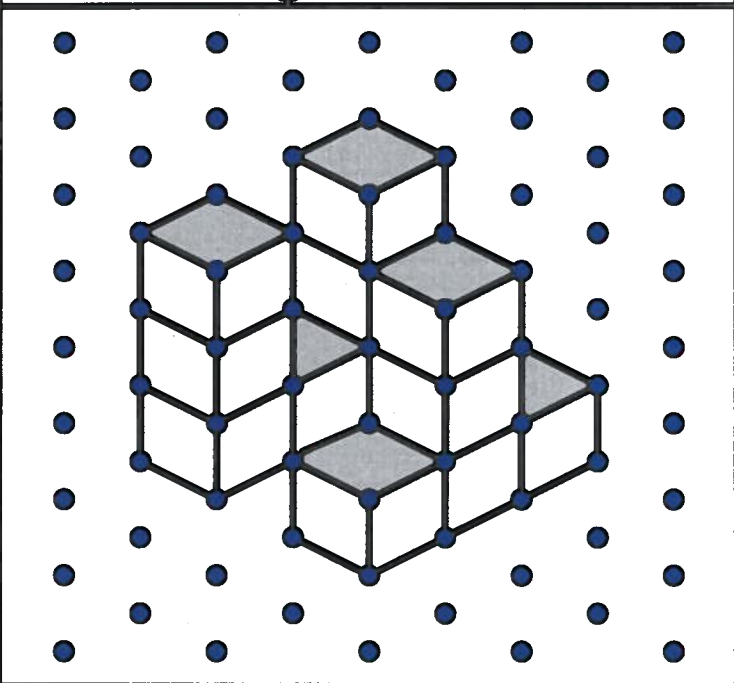

Figure D.4