

BATHROOMS, BATHING FACILITIES, SHOWER ROOMS, CLOSETS, GRAB BARS AND HANDRAILS

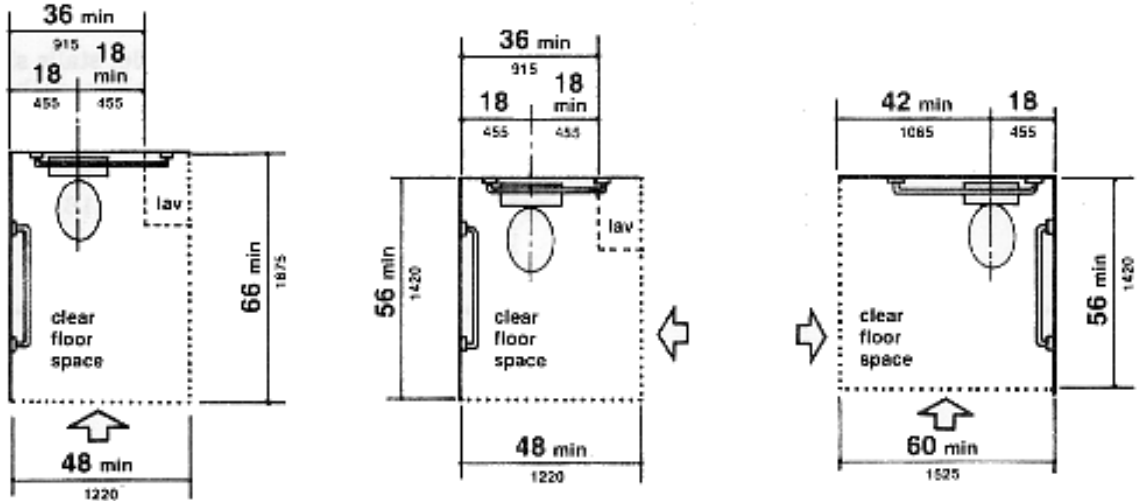

Figure 28 (4.16.2)
Clear Floor Space at Water Closets

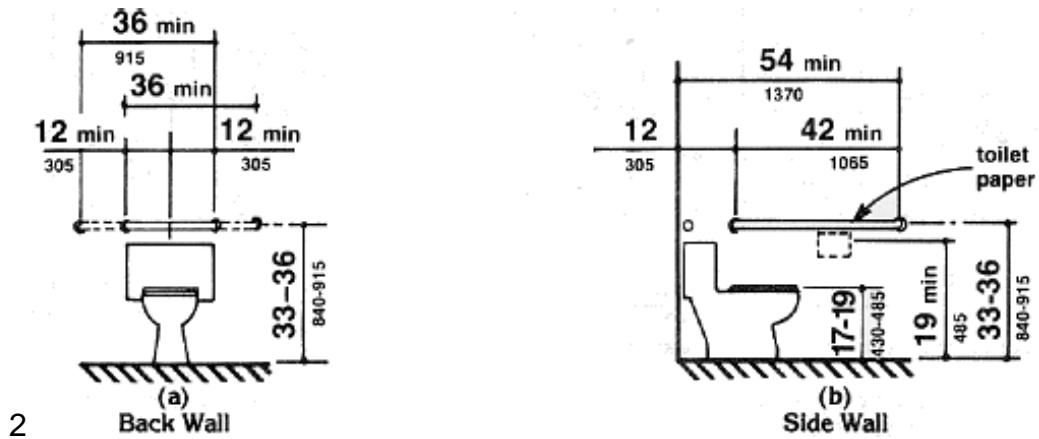

Figure 29 (4.16.4)
Grab Bars at Water Closets

BATHROOMS, BATHING FACILITIES, SHOWER ROOMS, CLOSETS, GRAB BARS AND HANDRAILS (Cont'd)

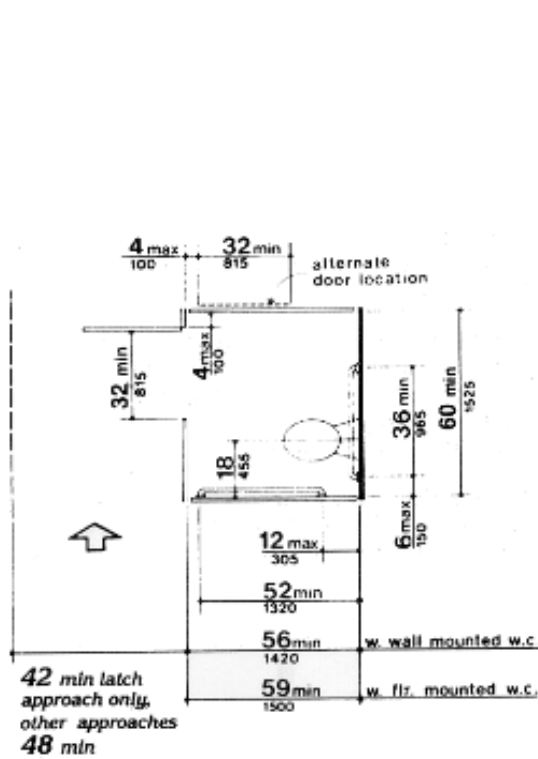

Figure 30a (4.17.6)
Toilet Stalls
Standard Stall

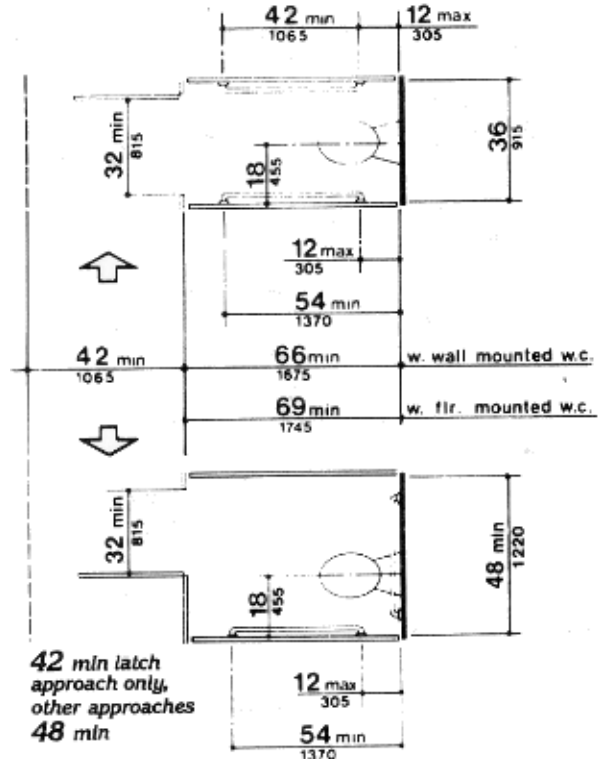

Figure 30b(4.17.6)
Toilet Stalls
Alternate Stalls

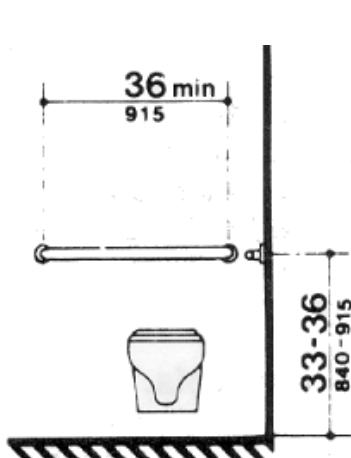

Figure 30c (4.17.6)
Toilet Stalls
Rear Wall of Standard Stall

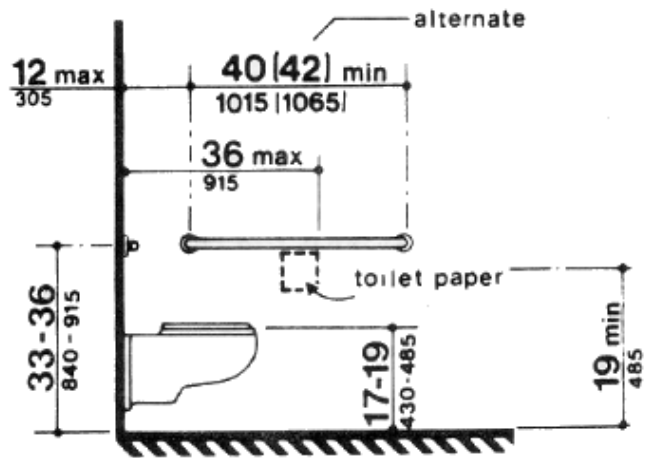

Figure 30d (4.17.6)
Toilet Stalls

BATHROOMS, BATHING FACILITIES, SHOWER ROOMS, CLOSETS, GRAB BARS AND HANDRAILS (Cont'd)

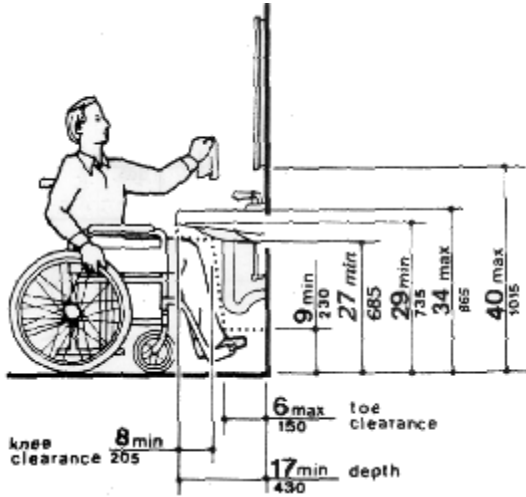

Figure 31 (4.19)
Lavatory Clearances

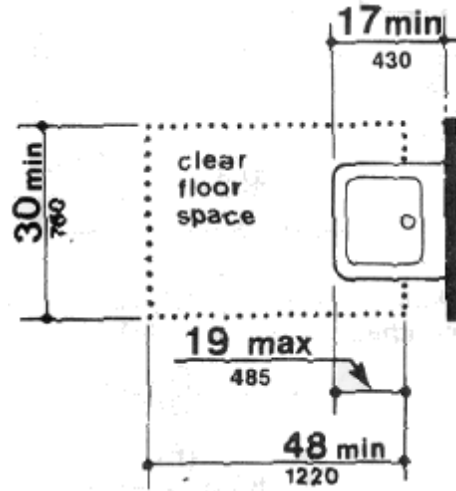

Figure 32 (4.19)
Clear Floor Space at Lavatories

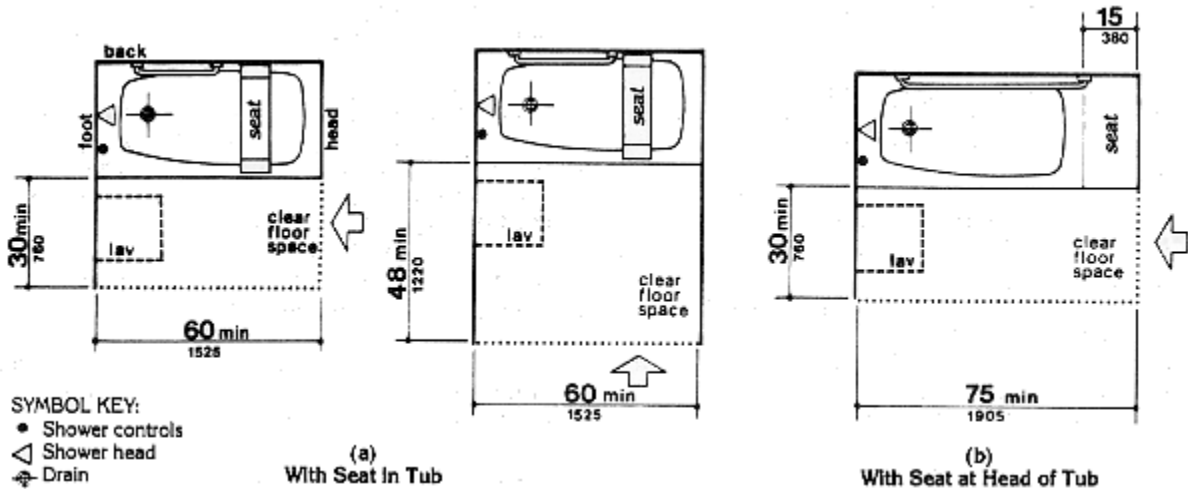

Figure 33 (4.20)
Clear Space at Bathtubs

BATHROOMS, BATHING FACILITIES, SHOWER ROOMS, CLOSETS, GRAB BARS AND HANDRAILS (Cont'd)

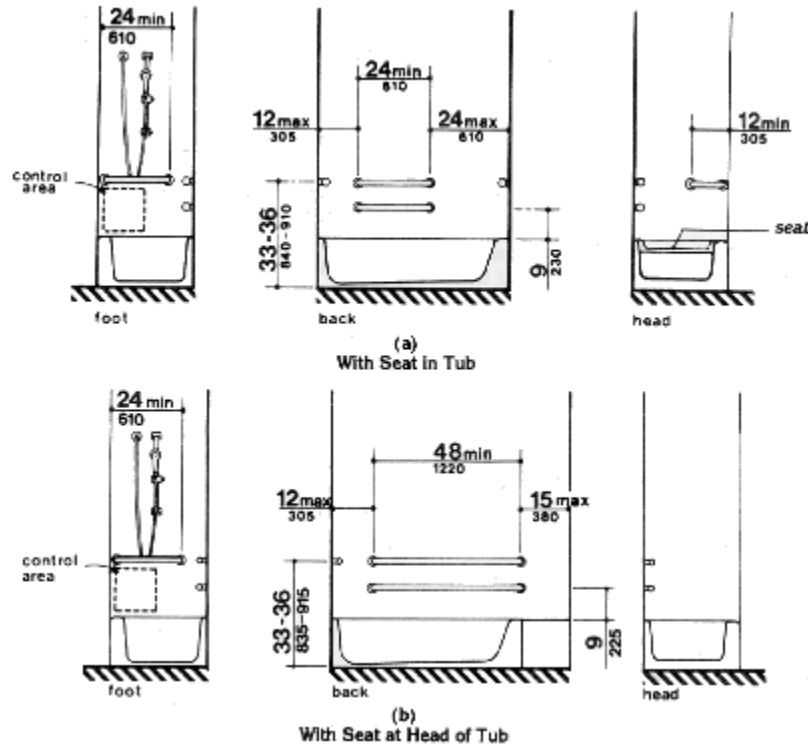

Figure 34 (4.20)
Grab Bars at Bathtubs

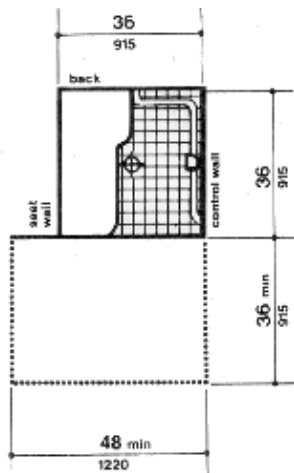

Figure 35a (4.21.2)

Shower Size and Clearances
36-in by 36-in (760mm by 1525mm) Stall

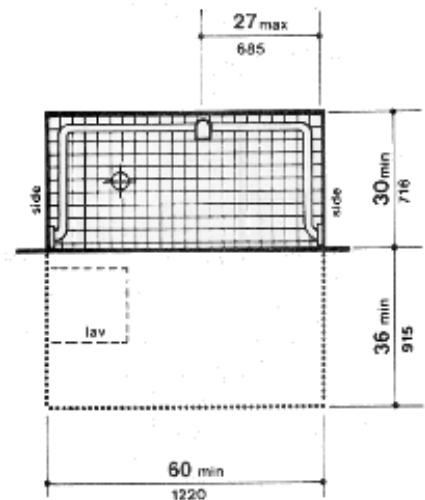
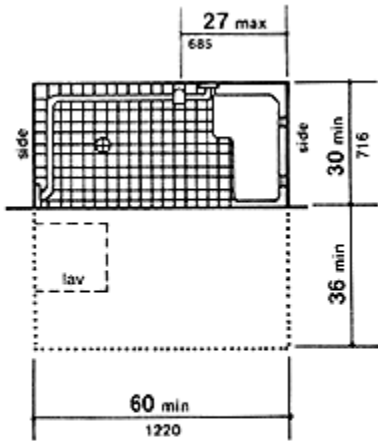

Figure 35b (4.21.2)

Shower Size and Clearances
30-in by 60-in (915mm by 915mm) Stall

BATHROOMS, BATHING FACILITIES, SHOWER ROOMS, CLOSETS, GRAB BARS AND HANDRAILS (Cont'd)



(a)

Fig. 57
 Roll-in Shower with Folding Seat

Figure 57a (4.21.2)
 Roll-In Shower with Folding Seat

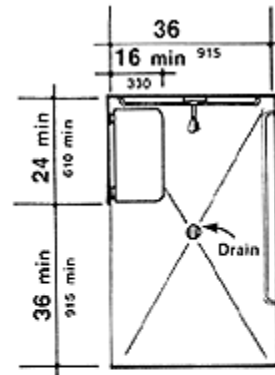

(b)

Fig. 57
 Roll-in Shower with Folding Seat

Figure 57b (4.21.2)
 Roll-In Shower with Folding Seat

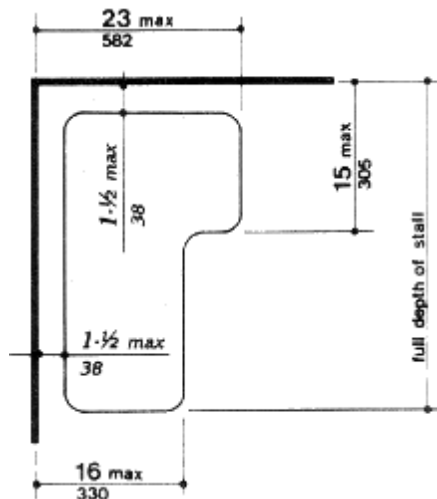

Figure 36 (4.21.3)
 Shower Seat Design

BATHROOMS, BATHING FACILITIES, SHOWER ROOMS, CLOSETS, GRAB BARS AND HANDRAILS (Cont'd)

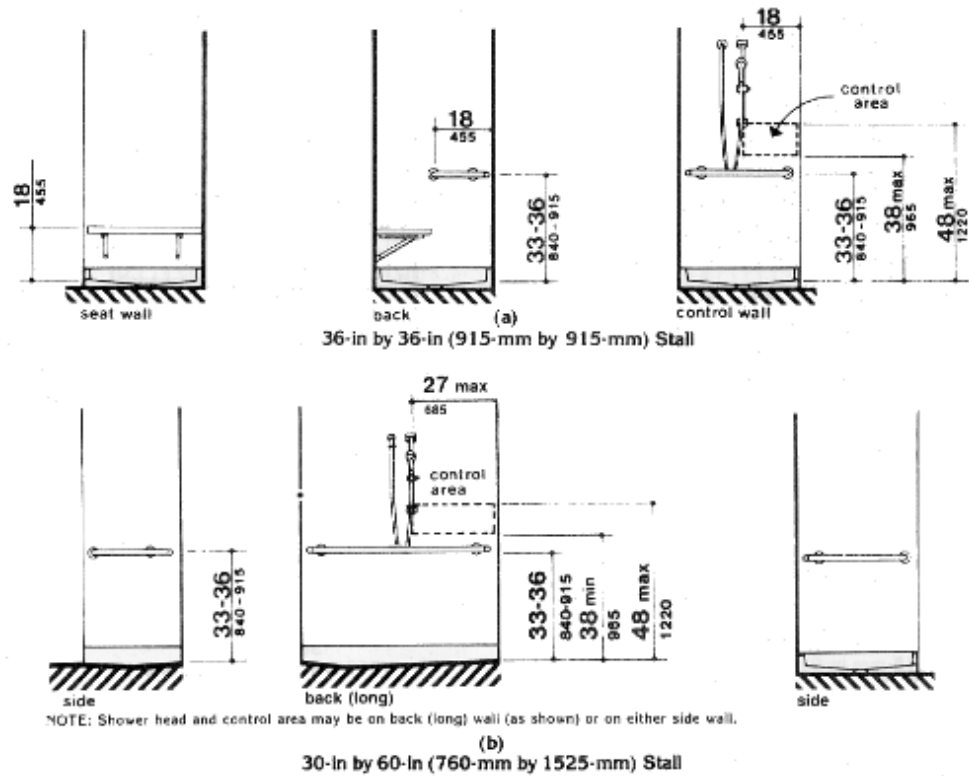

Figure 37 (4.21)
Grab Bars at Shower Stalls

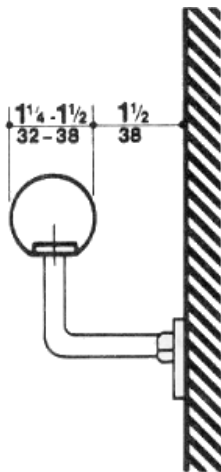

Figure 39a

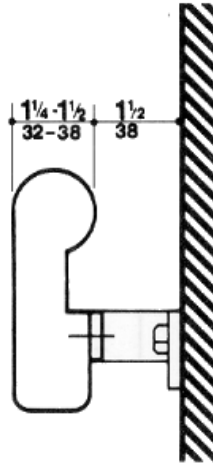

Figure 39b (4.26.2)

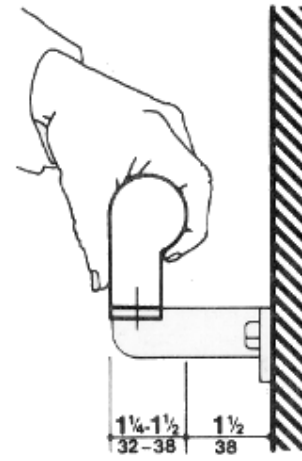

Figure 39c

Size and Spacing of Handrails and Grab Bars

BATHROOMS, BATHING FACILITIES, SHOWER ROOMS, CLOSETS, GRAB BARS AND HANDRAILS (Cont'd)

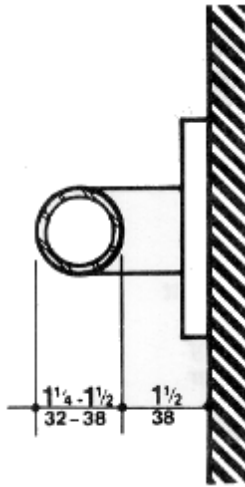

Figure 39e (4.26.2)

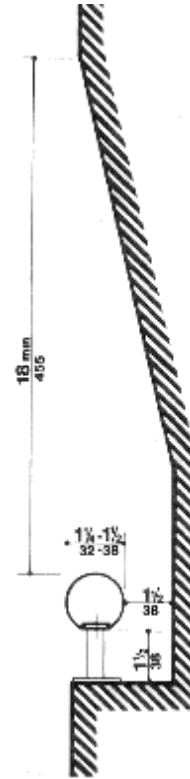

Figure 39d (4.26.2)

Size and Spacing of Handrails and Grab Bars

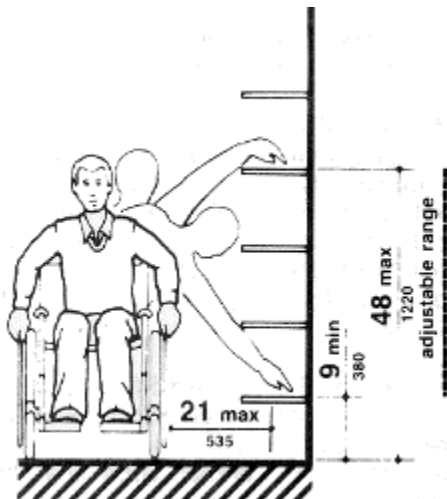

Figure 38a (4.25.3)

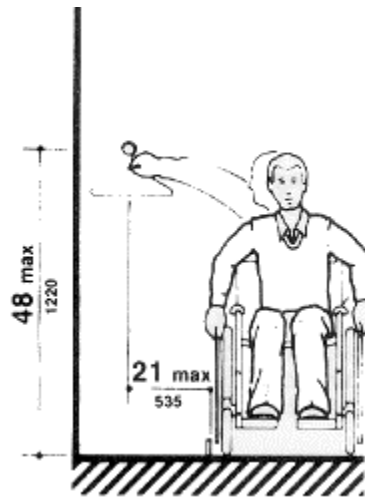

Figure 38b (4.25.3)

Storage Shelves and Closets